

SANYO	No. 4357	LC7538NM
	Electronic Volume Control System for Car Audio	

Overview

The LC7538NM is a fully equipped electronic volume IC which permits significant reductions in externally connected components while providing ample volume, balance, loudness, fader, bass and treble control functions.

Features

- **Volume** : 81 positions ranging from 0 dB to -79 dB (in 1 dB increments) plus -∞. Separate left and right control provides excellent balance function.
- **Loudness** : Loudness operation provided by externally attached CR to activate tap at the -20 dB position of the volume ladder resistor.
- **Fader** : Fader function traversing 16 positions with rear or front attenuated output only (these 16 positions consist of 2 dB step intervals ranging from 0 dB to -20 dB, 5 dB step intervals ranging from -20 dB to -45 dB, plus the end settings of -60 dB and -∞).
- **Bass and Treble**: Using externally attached C (capacitor), the LC7538NM provides bass-treble mutual 15-position control and formats a NF-form tone control circuit (LUX form).
- **On-chip OP amplifier** for caching applications reduces external components.
- **Reduced switching noise** with silicon gate CMOS processor.
- **All controls performed using serial data input (C'B).**

Package Dimensions

unit : mm
3129-MFP36S

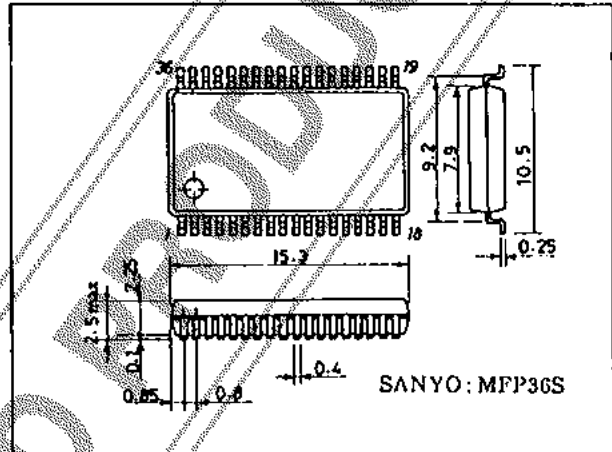

Specifications

Absolute Maximum Ratings at Ta = 25°C, VSS = 0V

				unit
Maximum supply voltage	V _{DD max}	V _{DD}	11	V
Input impression voltage	V _{IN max1}	CL, DI, CE	V _{SS} -0.3 to V _{DD} +0.3	V
	V _{IN max2}	LTIN, RTIN, L5dBIN R5dBIN, L1dBIN, R1dBIN LFIN, RFIN	V _{SS} -0.3 to V _{DD} +0.3	V
Allowable power dissipation	Pd max	Ta≤85°C	280	mW
Operating temperature	Topg		-40 to +85	°C
Storage temperature	Tsig	*1	-50 to +125	°C

*1 When mounting the QIP package on the board, do not dip the entire package in solder.

Continued on next page.

Specifications and information herein are subject to change without notice.

SANYO Electric Co., Ltd. Semiconductor Business Headquarters

10KYO OFFICE: Tokyo Bldg., 1-10, 1-Chome, Ueno, Futo-ku, TOKYO, 110 JAPAN

LC7538NM

Continued from preceding page.

Allowable Operation Conditions at $T_a = 25^\circ\text{C}$, $V_{SS} = 0\text{V}$

			min	typ	max	unit
Supply voltage	V_{DD}	*2	7.0		10.0	V
Input "H" level voltage	V_{IH}	CL, DI, CE	4.0		V_{DD}	V
Input "L" level voltage	V_{IL}	CL, DI, CE	V_{SS}		1.0	V
Input amplitude voltage	V_{IN}	L1IN, RTIN, L5dBIN, R5dBIN L1dBIN, R1dBIN, LF1IN, RF1IN	V_{SS}		V_{DD}	V _{p-p}
Input pulse width	t_{PW}	CL	1			μs
Setup time	t_{SETUP}	CL, DI, CE	1			μs
Hold time	t_{HOLD}	CL, DI, CE	1			μs
Operating Frequency	f _{opg}	CL			500	kHz

*2 A capacitor rated at 2000 pF or less should be installed between all power supply pins and V_{SS} .

Electrical Characteristics at $T_a = 25^\circ\text{C}$, $V_{DD} = 9\text{V}$, $V_{SS} = 0\text{V}$

			min	typ	max	unit
Total harmonic distortion	THD (1)	$V_{IN} = 1\text{V}_{rms}$, $f = 1\text{kHz}$, total overall flat		0.04		%
	THD (2)	$V_{IN} = 1\text{V}_{rms}$, $f = 20\text{kHz}$, total overall flat		0.06		%
Crosstalk	CT	$V_{IN} = 1\text{V}_{rms}$, $f = 1\text{kHz}$, total overall flat, $R_g = 1\text{k}\Omega$	60	87		dB
Maximum Output Reduction	V_o min	$V_{IN} = 1\text{V}_{rms}$, $f = 1\text{kHz}$, main volume \rightarrow , fader volume \rightarrow , $C = 1000\ \mu\text{F}$ between V_{ref} and V_{SS} for L/R		82		dB
All Resistance Value	R_{VOL} (1)	5dB step	15	25	35	$\text{k}\Omega$
	R_{VOL} (2)	1dB step	12	20	28	$\text{k}\Omega$
	R_{FADER}		12	20	28	$\text{k}\Omega$
	R_{BASS}		48	80	112	$\text{k}\Omega$
	R_{TREBLE}		30	50	70	$\text{k}\Omega$
Input "H" level current	I_{IH}	$V_I = 8\text{V}$ (CL, CE, DI pins)			10	μA
Input "L" level current	I_{IL}	$V_I = 0\text{V}$ (CL, CE, DI pins)	-10			μA
Output noise voltage	V_N	All overall flat (JHF-A), $R_g = 1\text{k}\Omega$		7.5	15	μV
Current consumption	I_{DD}	$V_{DD} = V_{SS} = 10\text{V}$		15	28	mA

Equivalent Circuit Block Diagram

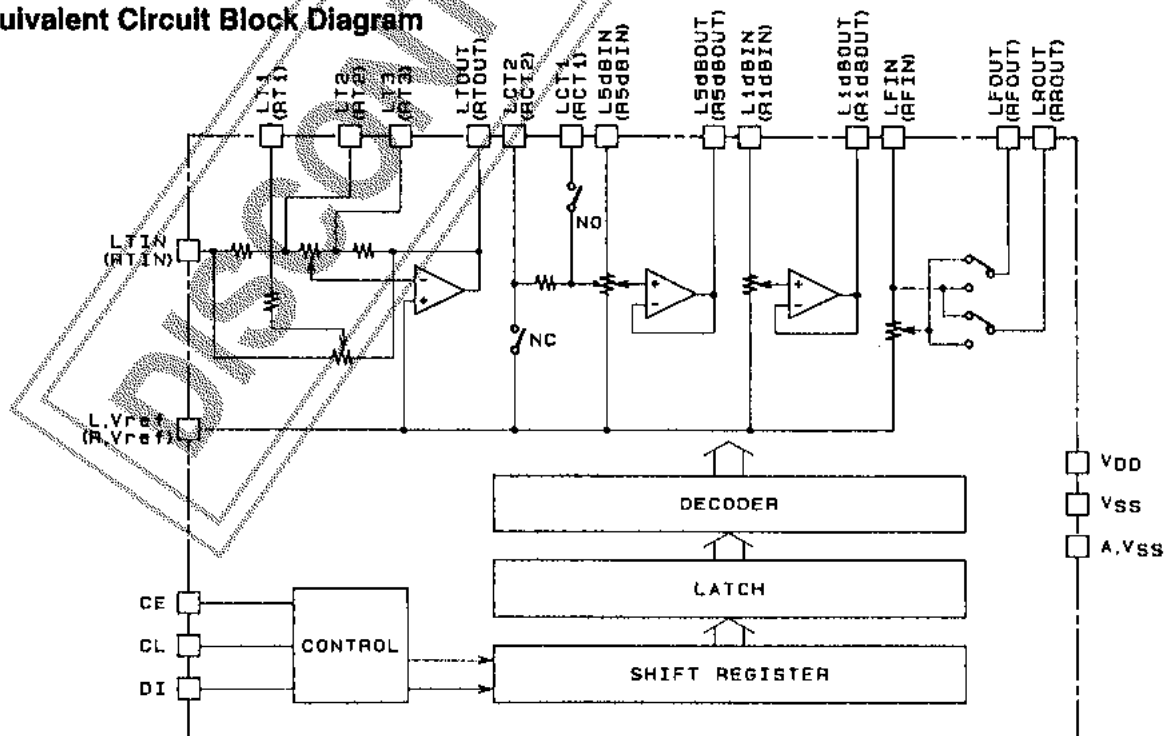

LC7538NM

Test Circuit

a) Total Harmonic Distortion

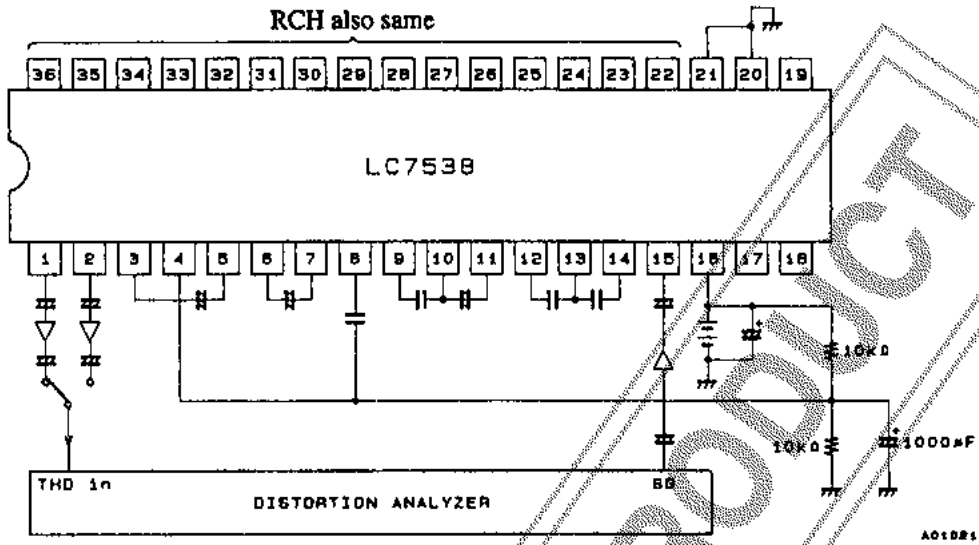

b) Output Noise Voltage

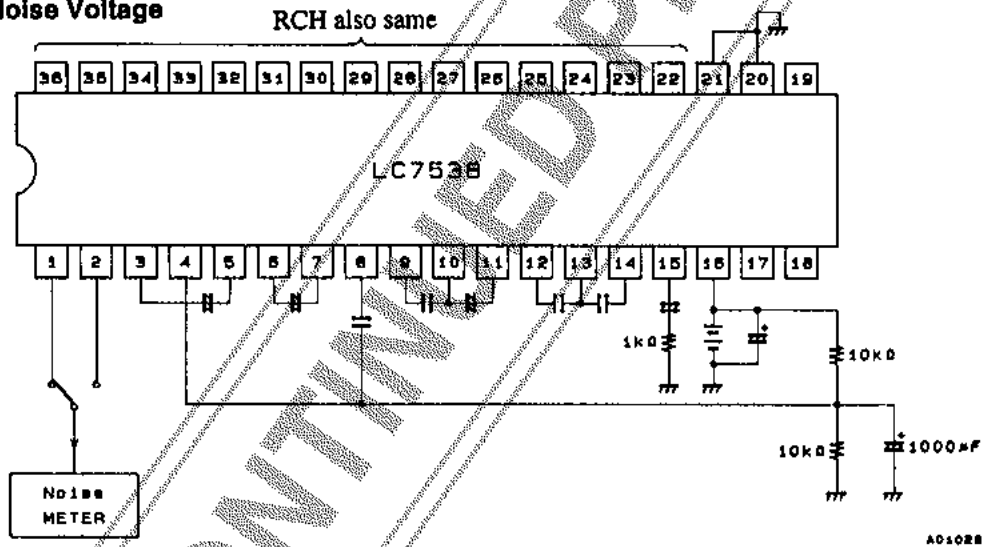

c) Crosstalk

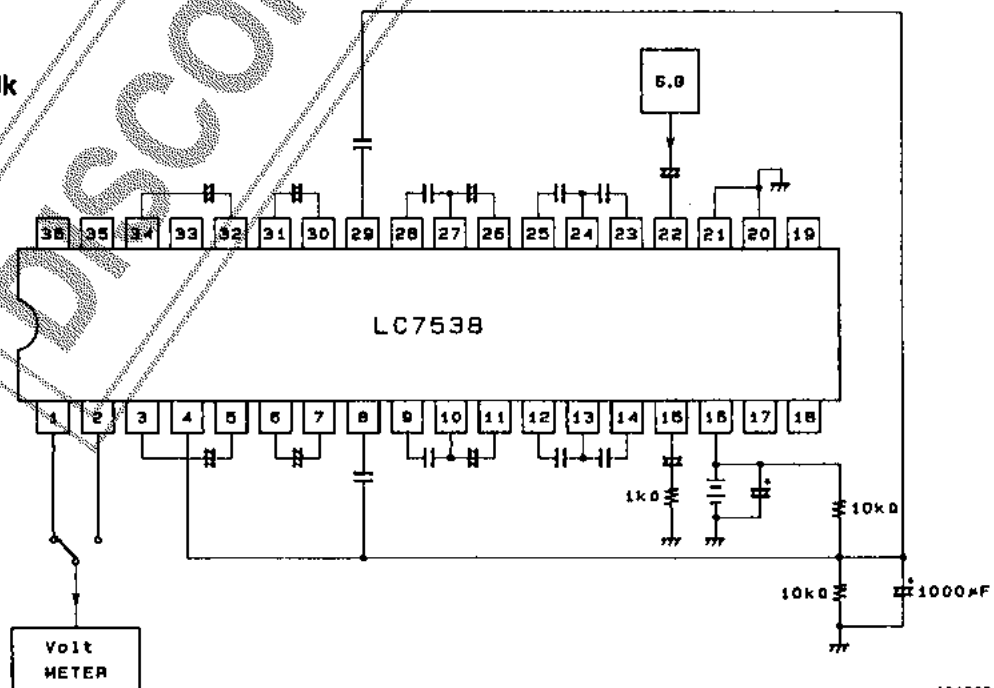

LC7538NM

Pin Assignment

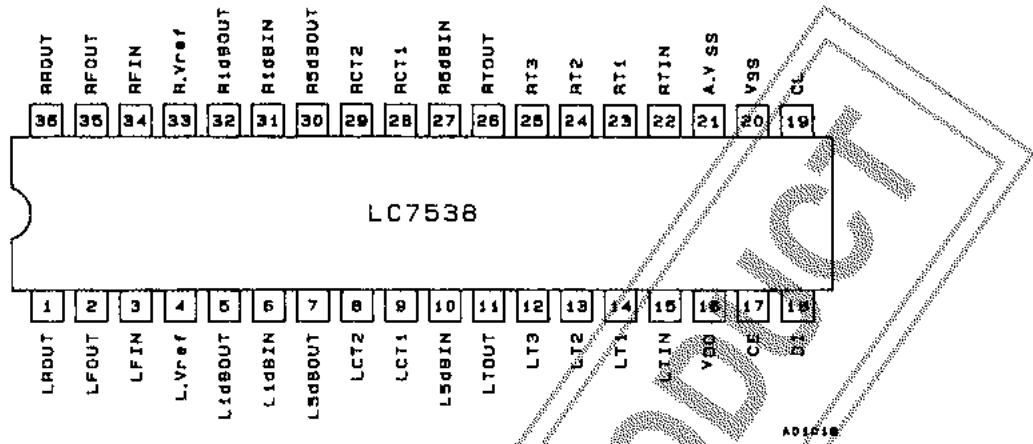

Pin Descriptions

Pin Name	Pin No.	Description	Remarks
LROUT	1	<ul style="list-style-type: none"> These pins function as output pins for the fader. Output reduction for rear and front is performed separately for each. Attenuation capacity is unified for both left and right. Step positioning is designed using an open circuit so that reception is performed using high impedance. 	
LFOUT	2		
RROUT	36		
RFOUT	35		
LFIN	3	<ul style="list-style-type: none"> When utilizing the fader function, these pins function as input pins. Low Impedance driven. 	
RFIN	34		
LVref	4	<ul style="list-style-type: none"> These pins are common pins for fader volume, tone and main volume. The pattern impedance connected here should be lowered as much as possible. LVref and RVref are not connected to V_{SS}. Connections for LVref and RVref to V_{SS} should be established externally to match all specifications. Notably, attention should be paid to capacity since capacitors are subject to residual resistance during volume output reduction when installed between LVref (RVref) and V_{SS} as is the case with single power sources. Normally, high voltage applied from V_{DD}. 	
RVref	33		
L1dBOUT	5	<ul style="list-style-type: none"> These pins are output pins for the 1 dB step attenuator located in the section main volume. 	
R1dBOUT	32		
L1dBIN	6	<ul style="list-style-type: none"> These pins are input pins for the 1 dB step attenuator located in the section main volume. Low Impedance driven. 	VR Resistance: 20kΩ
R1dBIN	31		
L5dBOUT	7	<ul style="list-style-type: none"> These pins are output pins for the 5 dB step attenuator located in the section main volume. 	
R5dBOUT	30		
LCT1	9	<ul style="list-style-type: none"> These pins are for loudness control. Connect a hi-band compensation capacitor between CT1 to 5dB IN and a low-band compensation capacitor between CT2 to Vref. 	
LCT2	8		
RCT1	28		
RCT2	29		
L5dBIN	10	<ul style="list-style-type: none"> These pins are input pins for the 5 dB step attenuator located in the section main volume. Low Impedance driven. 	
R5dBIN	27		

Continued on next page.

LC7538NM

Continued from preceding page.

Pin Name	Pin No.	Description	Remarks
LTOUT	11	• These pins are output pins for tone control.	
RTOUT	26		
LT3	12	• These pins are for connecting bass and treble compensation for the tone circuit. Connect a high-band compensation capacitor between T1 and T2. Connect a low-band compensation capacitor between T2 and T3.	
LT2	13		
LT1	14		
RT3	25		
RT2	24		
RT1	23		
LTIN	15	• These pins are tone control input pins.	
RTIN	22	• Low impedance driven.	
V _{DD}	16	• These pins are for connecting all power supplies.	
A. V _{SS}	21		
V _{SS}	20		
CE	17	• This is the chip enable pin. According to the timing of the switch from high to low, data is written to an internal latch and all analog switches operate. Data transfer with high level switches to enable.	
DI	18	• These are input pins for the clock and serial data for control.	
CL	19		

Equivalent Circuit for Main Volume Section

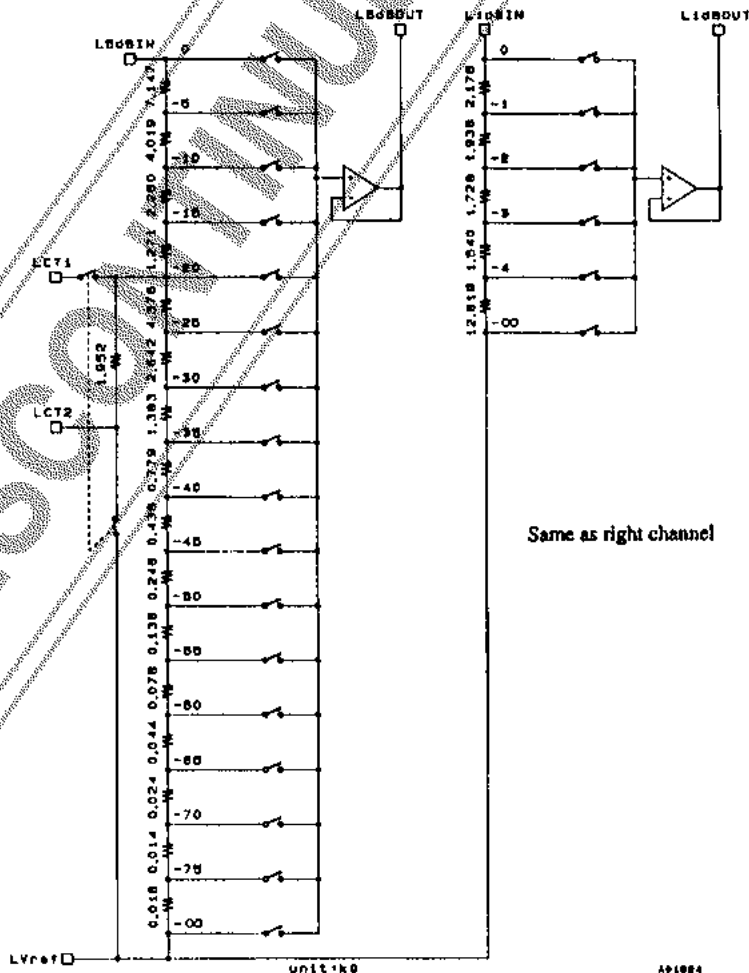

Equivalent Circuit for Fader Volume Section

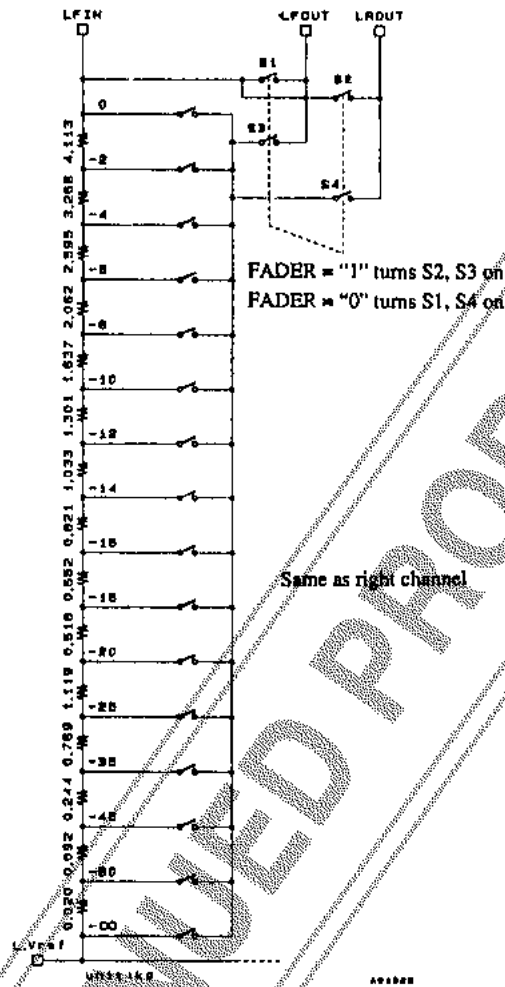

When data of \rightarrow is transferred to main volume control 1 dB step, S1 and S2 open and are turned on simultaneously.

Equivalent Circuit for Tone Section

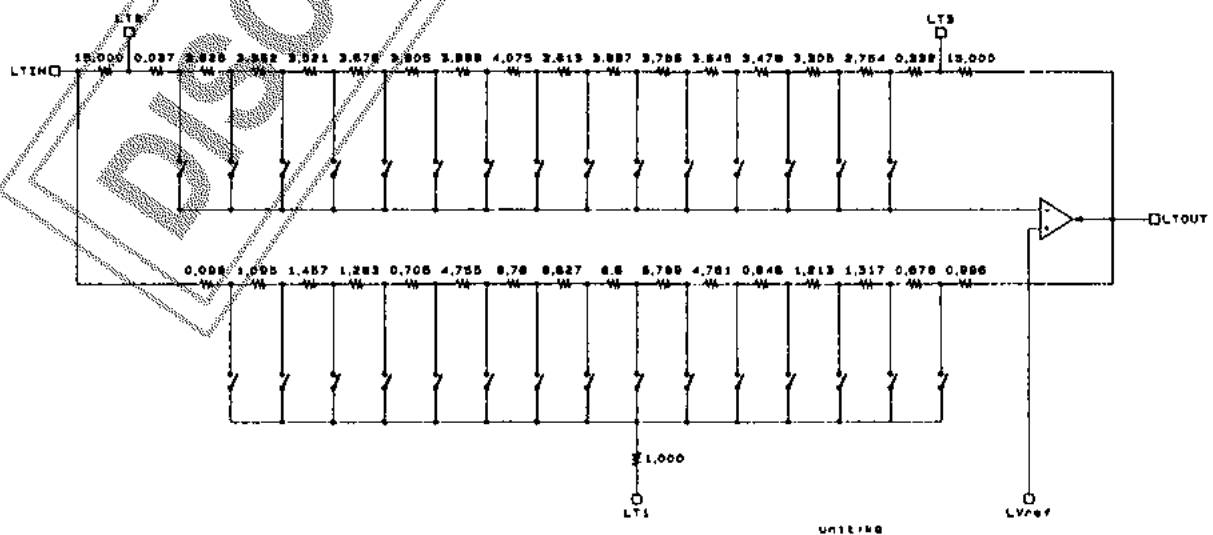

LC7538NM

Control System Timing and Data Format

Controlling of LC7538NM involves the input of regulating serial data to CE, CL and DI pins. Data format consists of 36 bits composed of an 8-bit address and 28-bit data.

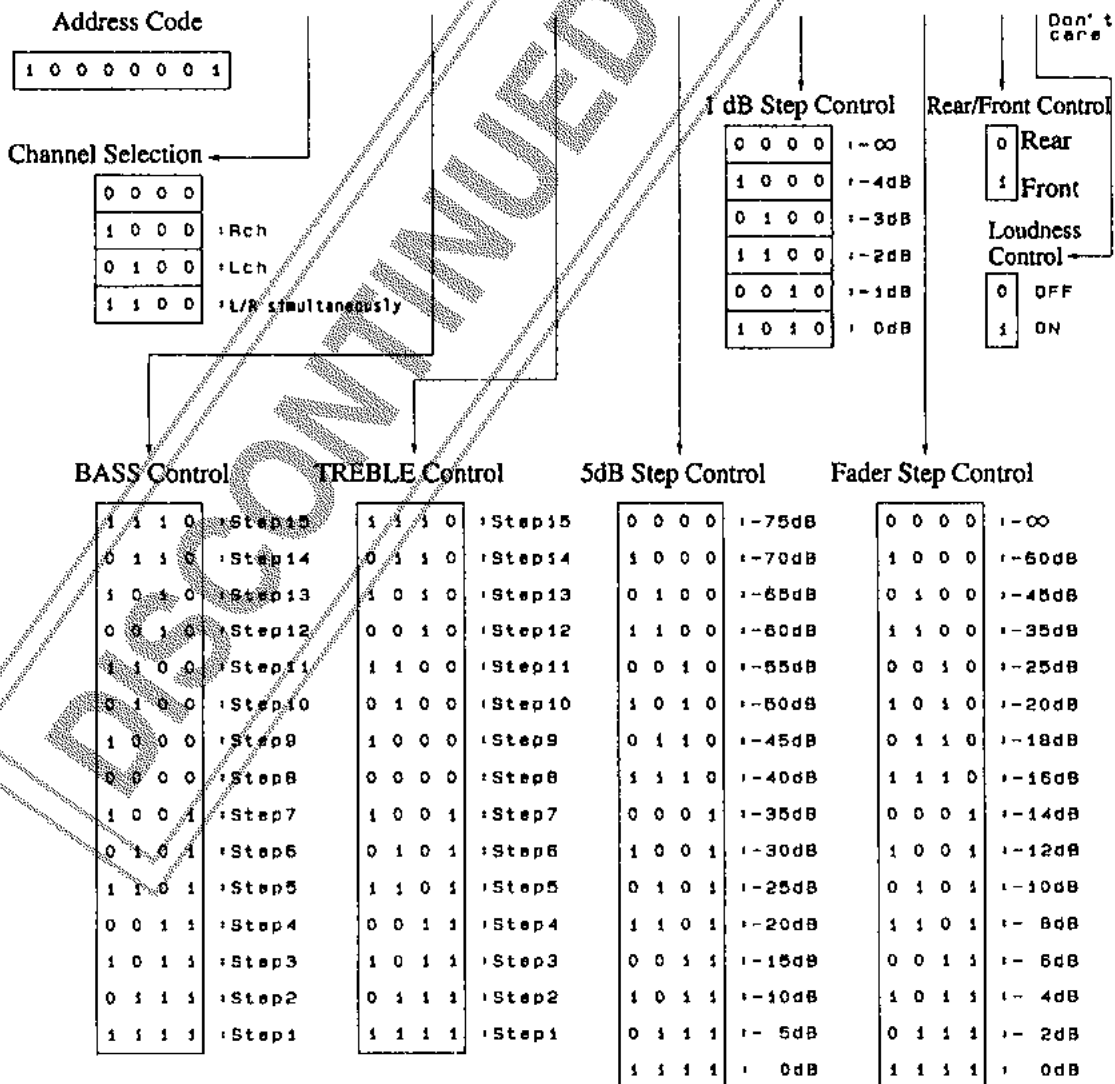
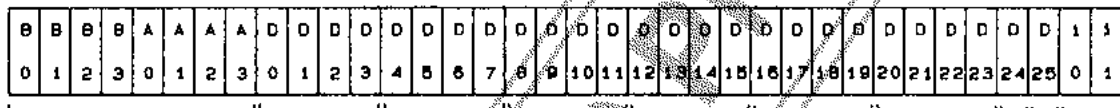
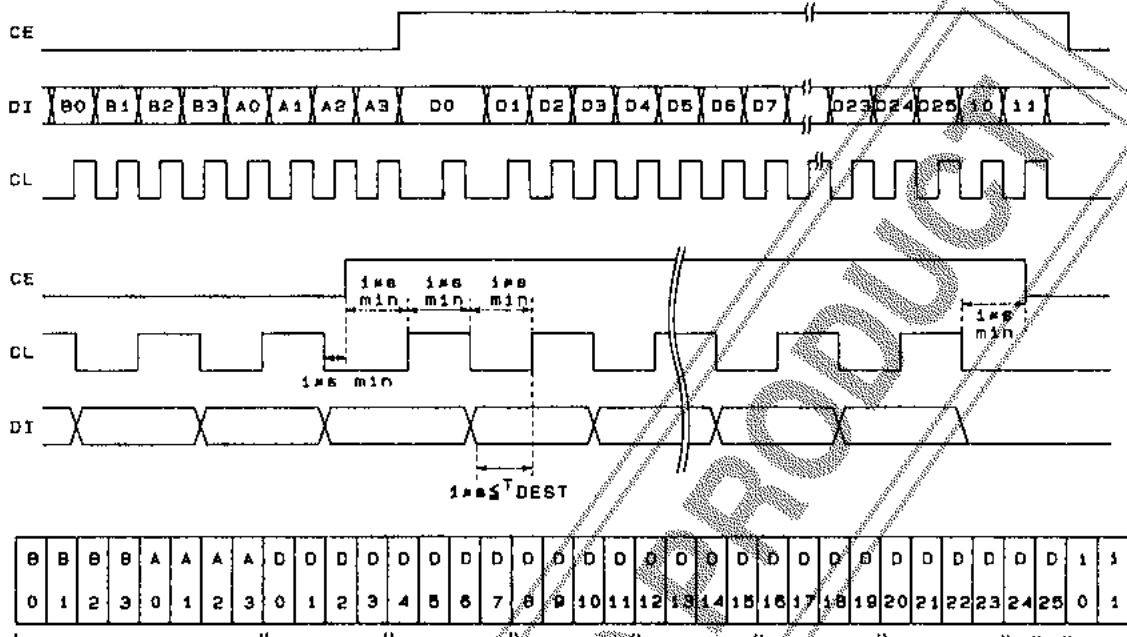

LC7538NM

Application Circuit Example

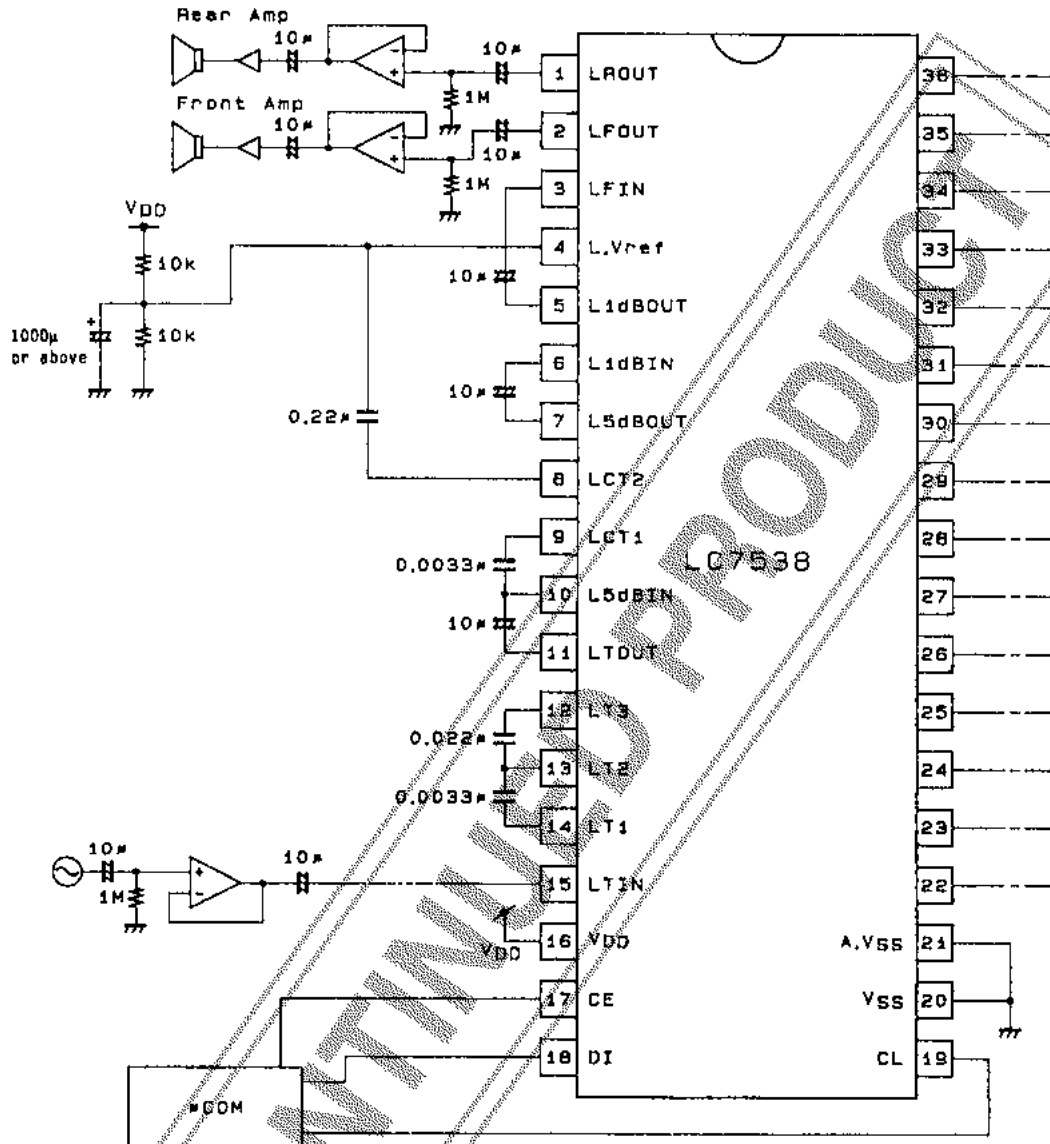

* (RCH also same)

A0102B

Note: Bipolar electrolytic capacitors should be used as widely as possible others are not recommended directly.

LC7538NM

Tone Characteristics

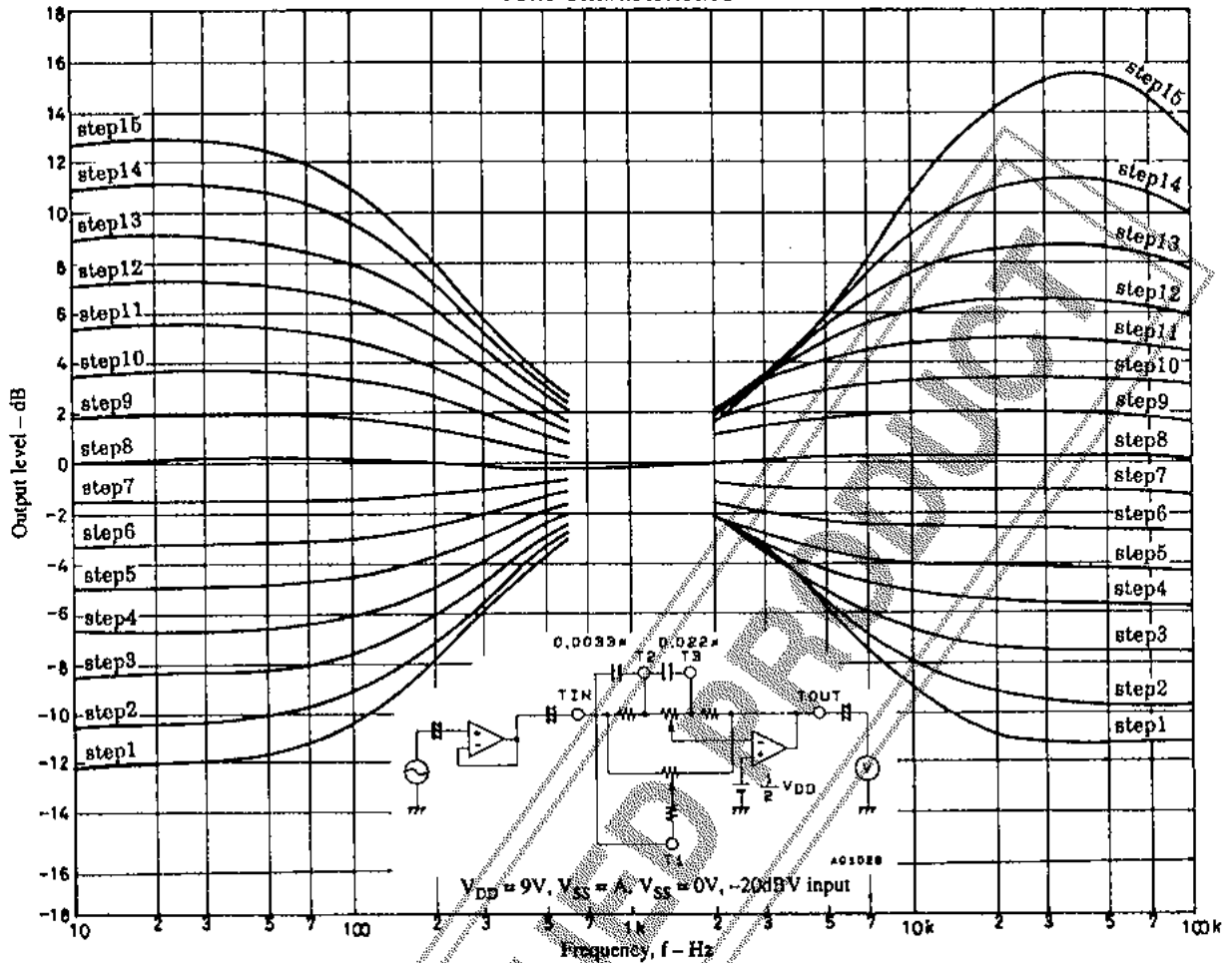

Main Volume Step Characteristics

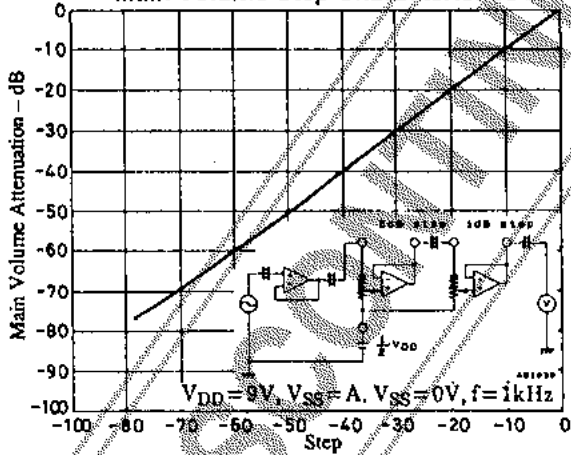

Fader Volume Step Characteristics

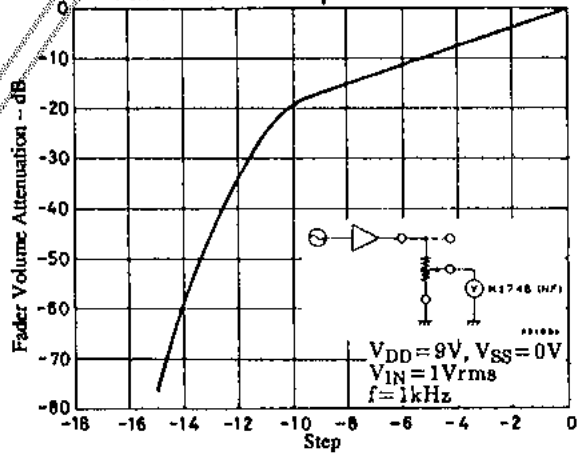

THD - Frequency response (1)

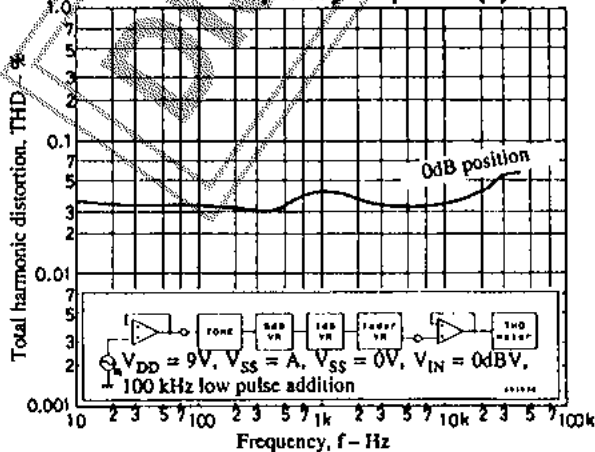

THD - Frequency response (2)

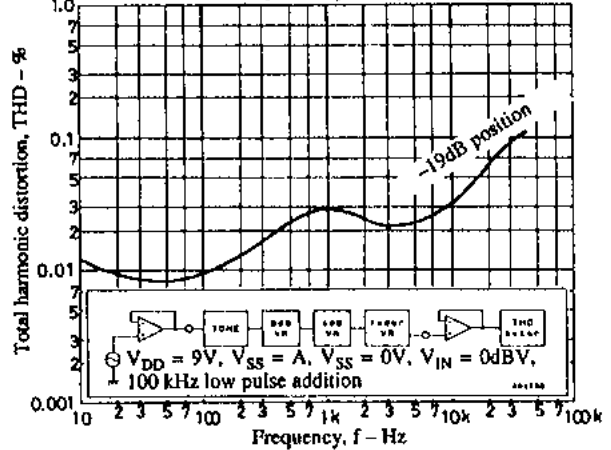

THD – Frequency response (3)

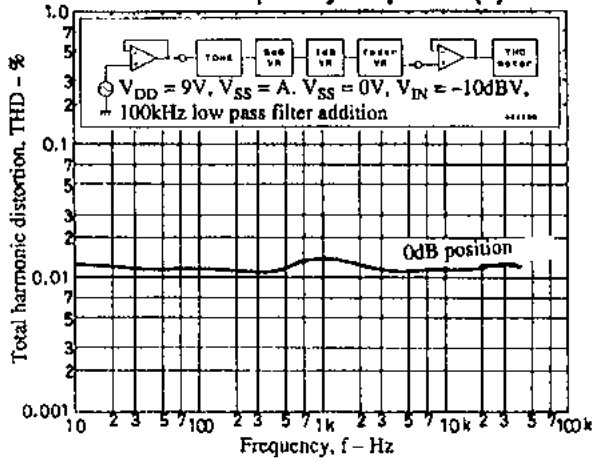

THD – Frequency response (4)

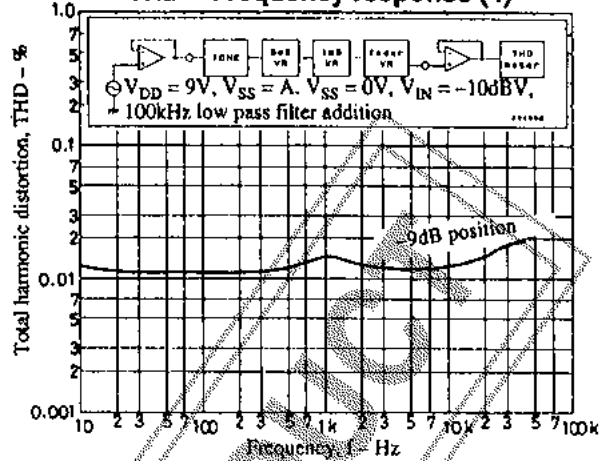

THD – Power Supply Voltage Characteristics (1)

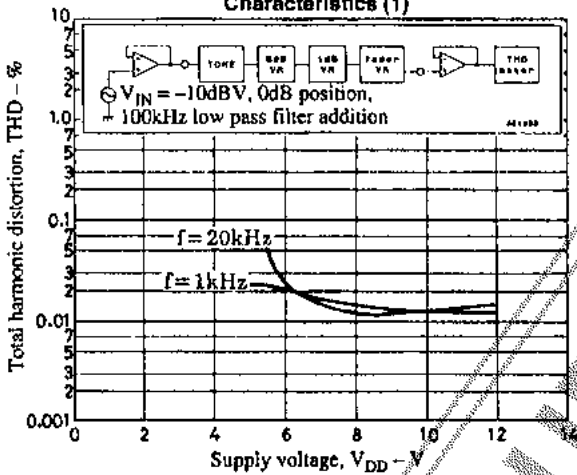

THD – Power Supply Voltage Characteristics (2)

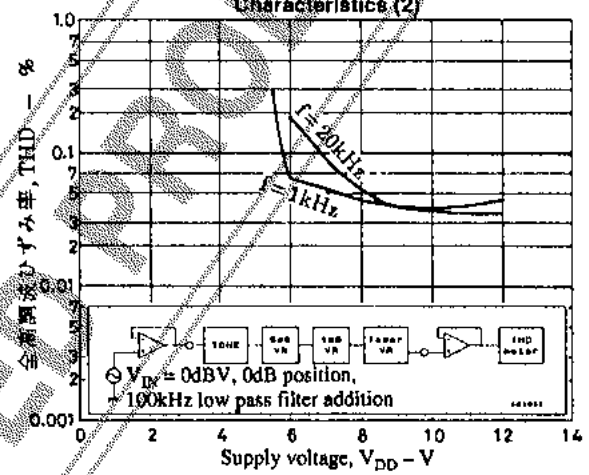

THD – Input Level Characteristics

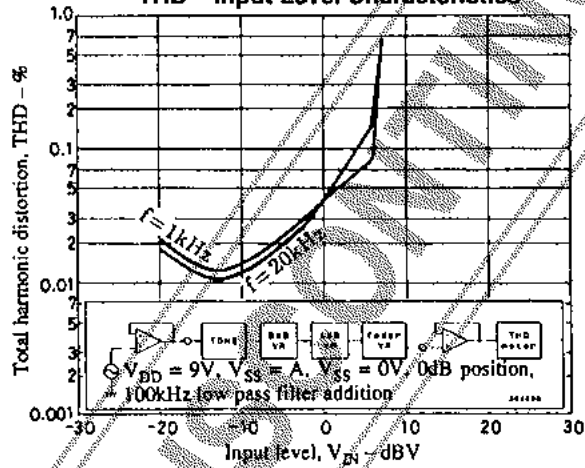

Loudness Characteristics

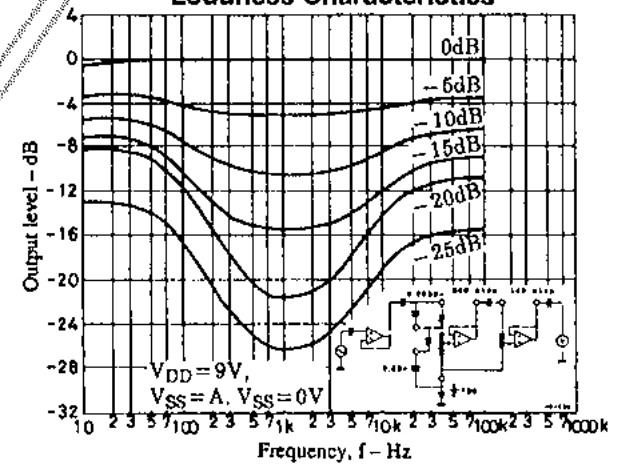

Loudness External Constant Calculation Sample

First, refer to page 5 where the 5 dB step internal equivalent circuit for the LC7538NM is shown. Using this information, an external constant for loudness can be added to establish a simplified circuit for computation as shown in figure 1. Computations gaining a 5 dB boost with $f = 100$ Hz using this configuration are shown in the following. ($f = 100$ Hz and 5 dB boost)

Within figure 1, when R and C are defined as:

$$R1 = R2 = 10 \text{ k}\Omega$$

$$R3 = 1 \text{ k}\Omega$$

$C1 = Z1, C2 = Z2$, then the following equation can be established:

$$V_{OUT} = \frac{\frac{R2 (R3 + Z2)}{R2 + R3 + Z2}}{\frac{R1 \cdot Z1}{R1 + Z1} + \frac{R2 (R3 + Z2)}{R2 + R3 + Z2}} = -20\text{dB}$$

(at = 1kHz)

$$V_{OUT} = \frac{\frac{R2 (R3 + 10 \cdot Z2)}{R2 + R3 + 10 \cdot Z2}}{\frac{R1 \cdot 10 \cdot Z1}{R1 + 10 \cdot Z1} + \frac{R2 (R3 + 10 \cdot Z2)}{R2 + R3 + 10 \cdot Z2}} = -15\text{dB}$$

(at = 100Hz)

thereby resulting in,

$$Z1 \approx 178.3 \text{ k}\Omega \text{ and } Z2 = 176 \Omega.$$

Under such conditions where $f = 1$ kHz, specifications may be satisfied if C (capacitor) having these impedances is supplied externally. The end result being that $C1 = 893$ pF and $C2 = 0.9$ μ F.

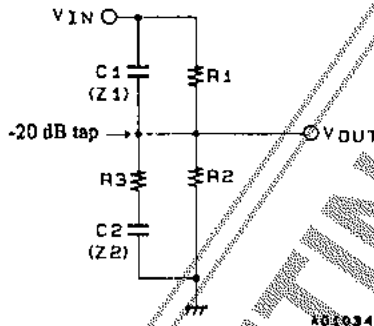

R1, R2 and R3 : LC7538NM on-chip resistors
 C1 : External high-band compensation capacitor
 C2 : External low-band compensation capacitor

Figure 1

Notes for Above Applications

- When the power supply is turned on, the internal analog switch inexact. Until data is set, counter measures such as those required for muting are performed externally.
- In order to prevent crossover into the analog system of high-frequency digital signals transferred to the CL, DI and CE pins, transfer along these signal lines should occur along shielded lines or prevented using the grounding pattern or the circuit.

Information (including circuit diagrams and circuit parameters) herein is for example only ; it is not guaranteed for volume production.

SANYO believes information herein is accurate and reliable, but no guarantees are made or implied regarding its use or any infringements of intellectual property rights or other rights of third parties.